



2019



# BRAZZEN

RURAL PRODUCTS

*TasRural*



“Built tough to take the hard bumps of the serious farmer”

[www.tasrural.supplies](http://www.tasrural.supplies)

# Contact & Sales

---

9 Kyeema Place, Cambridge 7170

Office: (03) 6245 1663

Phone: 0414 832 494

[www.tasrural.supplies](http://www.tasrural.supplies)  
[admin@tasrural.supplies](mailto:admin@tasrural.supplies)

**[www.tasrural.supplies](http://www.tasrural.supplies)**

# Product Index

## Cattle 2-16

Head Bale	2
Crushes	2
Ramps	6
Panels	8
Bows	9
Gates	10
Force Yards	13
2 Way Race Gate	14
Spear Trap Gate	14
Curved Race Panels	15
Bud Box	15
Calf Cradle	16
Access Grid	16

## Sheep 17-21

Ramps	17
Curved Race Kit	18
V-Race	19
Panels & Gates - Premium	20
Panels & Gates - Brazen	21

## Horses 22-23

Float Panels	22
Shelter	22
Panels	23
Gates	23

## Feeders 24-27

Cattle Feeders	24
Sheep Feeders	25
Lick Feeders	26
Bale Trailer	27

## ATV Trailer 28

## Dog Pen 29





# CATTLE CRUSH



## Head Bale

- Ideal for use with two cattle panels and a sliding gate to create a budget crush
- Easy to operate ratchet system
- Head bale is 750mm inside and 850mm outside

		Width	Depth	Height	Weight
Head Bale	<b>CHB</b>	850 (2.79')	250 (0.8')	2100 (6.89')	108kg (238lb)



## Hobby Crush

- Ideal for the hobby farmer
- Simple construction
- Portable
- Easy operating sliding gate
- Anti Bruise Oval rail panels

### Kit Includes:

- 1x Cattle Head Bale
- 2x Cattle Panels
- 1x Cattle Sliding Gate

		Length	Depth	Height	Weight
Hobby Crush	<b>CCH</b>	2500 (8.2')	700 (2.8')	2030 (7.5')	260kg (573lb)

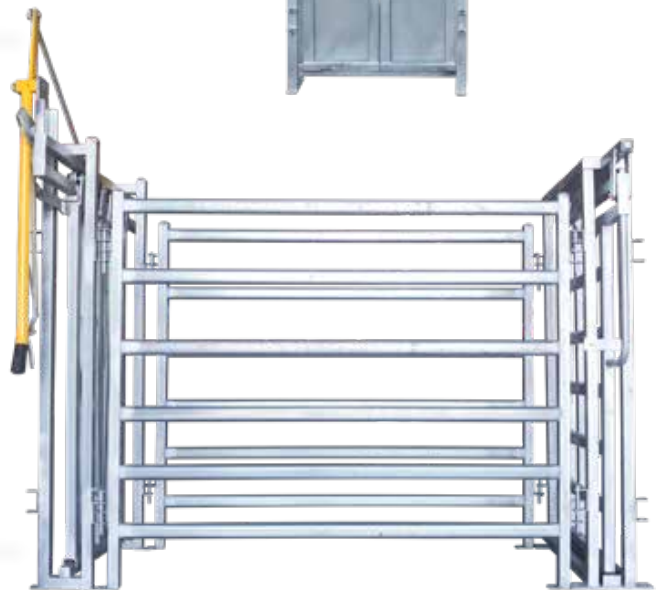

## Load Scales

- Weight Capacity: 3000kg (6600lb)
- With OIML and CE approved KELI load cells
- Mild-steel Structure, Ushape by modules, powder coated
- YAOHUA A12E indicator
- Junction box and 5m (16') cable
- 5mm checker plate

		Length	Depth	Height	Weight
Load Scales	<b>CS</b>	1900 (75')	700 (2.8')	150mm (0.5')	90kg (198lb)

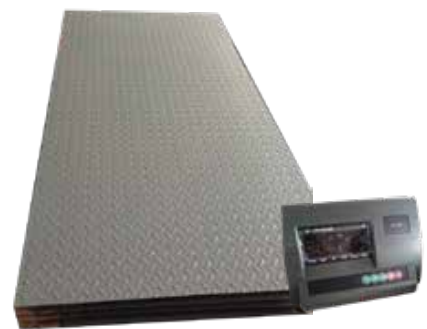





## Standard Crush

- Anti Bruise Oval rails
- Sheeted bottom side gates for operator and animal safety
- Triple top gates allowing full access along animal
- Auto Lock rear sliding gate
- Adjustable rear handle
- Walk through vet section
- Supplied in Flat Pack



	Length	Depth	Height	Weight
Standard Crush <b>CCSFP</b>	3350(11')	700(2.8')	2030(7.5')	437kg(964lb)



# CATTLE CRUSH



## Premium Crush

- 3mm gauge steel frame
- Walk through vet section
- Bulk gate
- Kick latch
- Rump squeeze
- New design allows safer access to rear of animal
- Triple top gates allowing full access along animal
- Double lower doors on each side for hoof access
- Sheeted sliding gate
- Long ratchet rump bar mechanism
- Auto lock rear sliding gate
- Supplied in Flat Pack



	Length	Depth	Height	Weight
Premium Crush CCPFP	3350(11')	700(2.8')	2030(7.5')	654kg(1442lb)





## Premium Squeeze Crush

- Anti Bruise Oval rails
- Sheeted head bail & bottom side gates for operator and animal safety
- Auto Lock rear sliding gate
- Innovative silent operation
- Walk through vet section
- Parallel squeeze
- 2x large access doors
- Neck inspection doors
- Front & rear head bale operation
- Supplied in flat pack

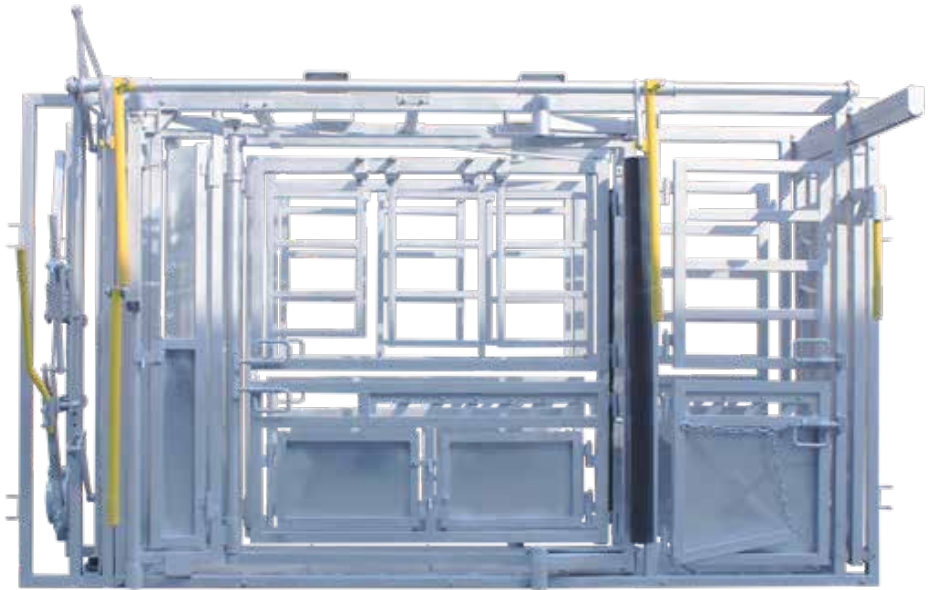

	Length	Depth	Height	Weight
Squeeze Crush <b>CCPSFP</b>	3350(11')	700(2.8')	2030(7.5')	870kg(1918lb)



# CATTLE RAMPS



## Adjustable Cattle Ramp

- Fully Adjustable Height for trailer to truck loading
- Designed to suit all cattle yards
- Ramps available with detachable walkways on request
- Minimum height - 680mm  
Maximum height - 1270mm



Optional Walkway Kit Available



STANDARD RAMP



PREMIUM RAMP

		Length	Depth	Height	Weight
Standard Ramp	<b>CRFP</b>	3280 (10.76')	850 (2.78')	3350 (11')	264kg(582lb)
Premium Ramp	<b>CRPFP</b>	3280 (10.76')	850 (2.78')	3350 (11')	295kg(650lb)
Walkway Kit	<b>CRWK</b>				60kg(132lb)



# MOBILE CATTLE RAMPS



## Mobile Cattle Ramp

- 1x 3.6m mobile cattle ramp
- Ideal for moving around property
- Not road registerable



STANDARD MOBILE RAMP

## Premium Mobile Ramp

- Robust construction
- 1x 3.6m mobile cattle ramp
- Ideal for moving around property
- Holds 12x portable cattle panels (not included)
- The Premium floor is WPC board which is a durable and long lasting material used to replace timber



PREMIUM MOBILE RAMP

**PANELS NOT INCLUDED WHEN ORDERING.**



	Length	Depth	Height	Weight
Standard Mobile <b>CRSM</b>	5330 (17.5')	2240 (7.35')	2680 (8.8')	420kg(926lb)
Premium Mobile <b>CRPM</b>	5330 (17.5')	2240 (7.35')	2680 (8.8')	545kg(1201lb)



# CATTLE PANELS



## Cattle Panels

### Budget Panel

This middle of the range panel, is equipped with:

- 6x Oval 60 x 30 (2.36" x 1.18") rails
- 2 SHS 40 x 40 (1.57" x 1.57") posts
- 4 easy to connect lugs
- 2 holes for ground pins

### Standard Panel

This strong heavy duty panel, is equipped with:

- 6x Oval 70 x 45 (2.75" x 1.57") rails
- 2 SHS 50 x 50 (2" x 2") posts
- 4 easy to connect lugs
- 2 holes for ground pins

### Premium Panel

This strong heavy duty panel, is equipped with:

- 6x Oval 115 x 42 (4.52" x 1.65") rails
- 2 SHS 50 x 50 (2" x 2") posts
- 4 easy to connect lugs
- 2 holes for ground pins

All panels can be pre-ordered in Hot Dip Galvanised (HDG) after welding.

Race Walkway Mesh is designed to assist with maximum access to the cattle while they are in the race, therefore giving you safe access above the cattle.



		Horizontal	Uprights	Rails	Height	Width	Weight
Budget Panel	<b>CPB2.1</b>	60x30	40x40	6	1800 (5.91')	2100 (6.89')	30kg(66lb)
Standard Panel	<b>CPS1.25</b>	70x40	50x50	6	1800 (5.91')	1250 (4.1')	35kg(77lb)
Standard Panel	<b>CPS2.1</b>	70x40	50x50	6	1800 (5.91')	2100 (6.89')	35kg(77lb)
Standard Panel	<b>CPS2.4</b>	70x40	50x50	6	1800 (5.91')	2400 (7.87')	41kg(90lb)
Standard Panel	<b>CPS3.35</b>	70x40	50x50	6	1800 (5.91')	3350 (11')	55kg(121lb)
Premium Panel	<b>CPP2.1</b>	115x40	50x50	6	1800 (5.91')	2100 (6.89')	43kg(94lb)
Premium Panel HDG	<b>CPP2.1H</b>	115x40	50x50	6	1800 (5.91')	2100 (6.89')	45kg(99lb)
Premium Panel	<b>CPP2.4</b>	115x40	50x50	6	1800 (5.91')	2400 (7.87')	55kg(121lb)
Premium Panel HDG	<b>CPP2.4H</b>	115x40	50x50	6	1800 (5.91')	2400 (7.87')	58kg(128lb)
Premium Panel	<b>CPP3.35</b>	115x40	50x50	6	1800 (5.91')	3350 (11')	74kg(163lb)
Premium Panel HDG	<b>CPP3.35H</b>	115x40	50x50	6	1800 (5.91')	3350 (11')	78kg(172lb)
Premium Panel	<b>CPP3.78</b>	115x40	50x50	6	1800 (5.91')	3780 (12.14')	80kg(176lb)
Premium Panel HDG	<b>CPP3.78H</b>	115x40	50x50	6	1800 (5.91')	3780 (12.14')	88kg(194lb)



BUDGET



STANDARD

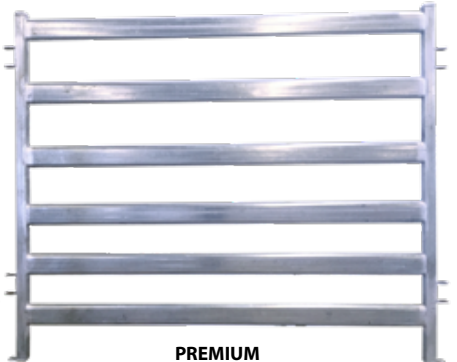

PREMIUM



## Race Bow

- Assists with maintaining a sturdy race

		Width	Depth	Height	Weight
Race Bow	<b>CRB</b>	850(2.78')	50(0.16')	2100(6.89')	18kg(40lb)



## Adjustable Race Bow

- Reduces turning in the race depending on size of animal
- Assists with maintaining a sturdy race

		Width	Depth	Height	Weight
Adjustable Bow	<b>CRBA</b>	850(2.78')	50(0.16')	2100(6.89')	40kg(88lb)



## Double Race Walkway Bow

- Assists with maintaining a sturdy race
- Creates a safe work area

		Width	Depth	Height	Weight
Race Bow	<b>CRBD</b>	2150(7.05')	50(0.16')	2655(8.7')	30kg(66lb)
Adjustable	<b>CRBDA</b>	2150(7.05')	50(0.16')	2655(8.7')	101kg(222lb)







# CATTLE GATES



## Cattle Gates

- Comes with both chain & slam latch
- Gate will swing in both directions

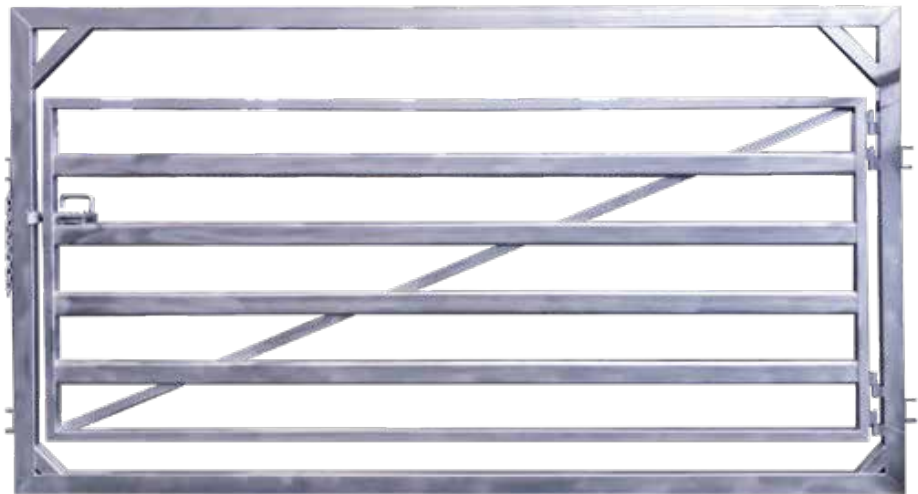

PREMIUM 4.2 GATE

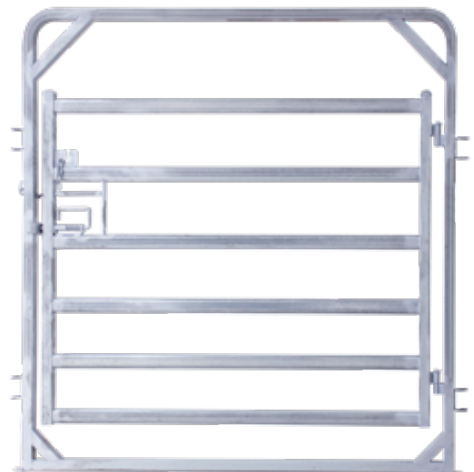

STANDARD 2.1 GATE

		Width	Depth	Height	Weight
2.1 Standard	<b>CGS2.1</b>	2100 (6.89')	50(0.16')	2200 (7.22')	73kg(161lb)
2.1 Premium	<b>CGP2.1H</b>	2100 (6.89')	50(0.16')	2200 (7.22')	77kg(170lb)
3.0 Standard	<b>CGS3.0</b>	3000 (9.84')	50(0.16')	2300 (7.55')	122kg(269lb)
4.2 Premium	<b>CGP4.2</b>	4200 (14.0')	50(0.16')	2300 (7.55')	263kg(580lb)



## Sliding Cattle Gate

- Ideal for use with two cattle panels and a sliding gate to create a budget crush
- Easy operation with roller sliding



*Suggestion for use:*  
1x Sliding Gate  
1x Head Bale  
2x Standard Panels



STANDARD SLIDING GATE

		Width	Depth	Height	Weight
Standard Gate	<b>CGSS</b>	850 (2.79')	220(0.7')	1970 (6.46')	80kg(176lb)
Premium Gate	<b>CGPS</b>	850 (2.79')	220(0.7')	1970 (6.46')	88kg(194lb)

## 2 Way Sliding Cattle Gate

- This sliding gate can be operated from both sides or locked off for single side operation



		Width	Depth	Height	Weight
2 Way Sliding	<b>CG2WS</b>	850(2.79')	370(1.21')	1970 (6.46')	92kg(203lb)



# ACCESS GATE



## Man Panel Gates

- Designed for easy access between yards
- Fast exit from yards



PREMIUM MAN-PANEL GATE

	Width	Depth	Height	Weight
Standard Man <b>CGM</b>	2100 (6.89')	50(0.16')	1800 (5.90')	60kg(132lb)
Premium Man <b>CGMP</b>	2100 (6.89')	50(0.16')	1800 (5.90')	65kg(143lb)
Standard Man <b>CGM2.4</b>	2400 (7.87')	50(0.16')	1800 (5.90')	68kg(150lb)
Premium Man <b>CGMP2.4</b>	2400 (7.87')	50(0.16')	1800 (5.90')	74kg(163lb)

## Access Gate

- Ideal for use in workers alley, or access to yards.
- Comes with both chain & slam latch
- Handy lugs for ground pinning



STANDARD ACCESS GATE

	Width	Depth	Height	Weight
Standard Access <b>CGA</b>	1250 (4.10')	50(0.16')	2200 (7.22')	46kg(101lb)
Premium Access <b>CGPA</b>	1250 (4.10')	50(0.16')	2200 (7.22')	55kg(121lb)





## Force Yards

- The Force Yard allows the handler to push cattle into the race system with minimal risk to the handler
- Innovative braking system stops the cattle from pushing the gate back therefore protecting the operator
- The curved layout works with the natural behaviour of how cattle run and tend to circle back to where they came from



Also Available in Offside Operation

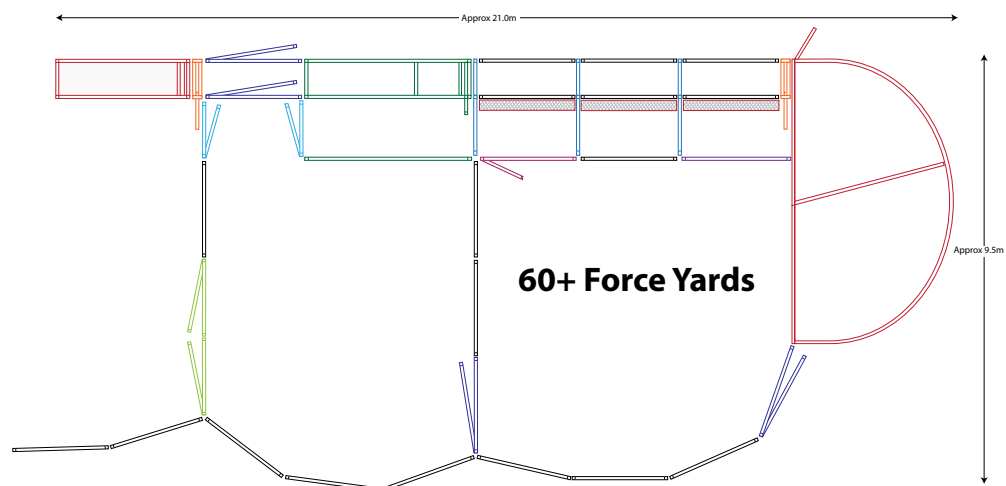

		Width	Depth	Height	Weight
Blind	<b>CFYB</b>	6300 (20.67')	3150 (10.33')	2200 (7.22')	498kg(1097lb)
Blind-Offside	<b>CFYBO</b>	6300 (20.67')	3150 (10.33')	2200 (7.22')	498kg(1097lb)



# 2 WAY RACE/SPEAR TRAP



## 2 Way Race Gate

- Easy operation
- Designed to assist with sorting and separating cattle with a minimal of stress on the animals
- Fully sheeted sides to help minimise cattle distraction
- Can be operated from both sides



	Length	Width	Height	Weight
2 Way Race Gate <b>CGR2W</b>	1642(5.39')	1653(5.42')	2100(6.9')	173kg(381lb)

## Spear Trap Gate

- Designed for self mustering
- Ideal for decreasing handling & increasing mustering efficiency on large properties
- Reduces stress on both the animal and handler!
- Arms are removable
- Effective and easy to install into an existing portable yard.

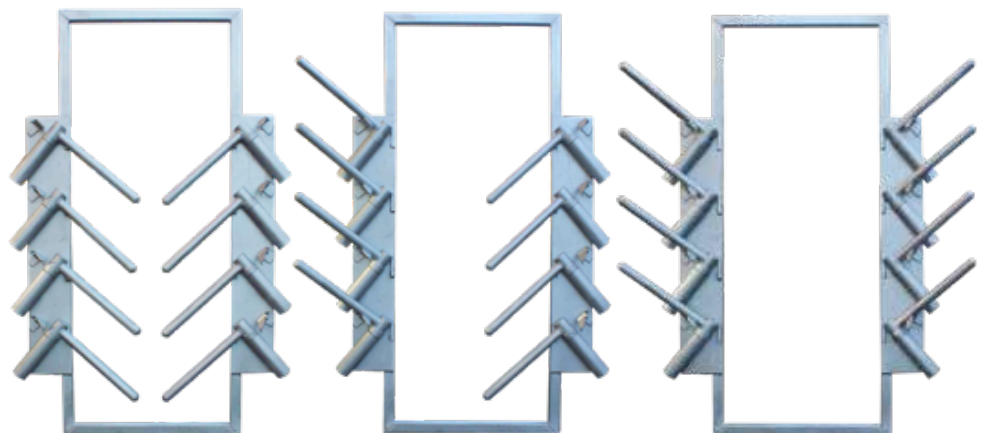

	Width	Depth	Height	Weight
Spear Trap Gate <b>CGST</b>	1150(3.7')	132(0.43')	2000(6.5')	86kg(189lb)

# CURVED RACE/BUD BOX



## Curved Race Panels

- Designed to improve speed of stock flow
- Minimal distractions



		Width	Depth	Height	Weight
Standard Outer	<b>CPCO</b>	3520 (11.5')	426(1.4')	1800 (5.9')	101kg(222lb)
Standard Inner	<b>CPCI</b>	3142 (10.3')	426(1.4')	1800 (5.9')	93kg(205lb)

## BUD BOX

- Designed to improve speed of stock flow



		Length	Width	Height	Weight
Bud Box	<b>CBB</b>	6316(20.7')	4860(15.9')	2200(7.2')	850kg(1874lb)





# CALF CRADLE/ACCESS GRID



## Calf Tilting Cradle

- Secure holding
- Galvanised construction
- Designed for easy access to animal



	Width	Depth	Height	Weight
Calf Cradle <b>CCCT</b>	1800 (5.90')	850 (2.79')	1200 (3.94')	207kg(456lb)

## Access Grid

- Animal Friendly
- Tested to 20 Tonne per axle
- Removable wings
- Designed with 5 bearers and 13 rails

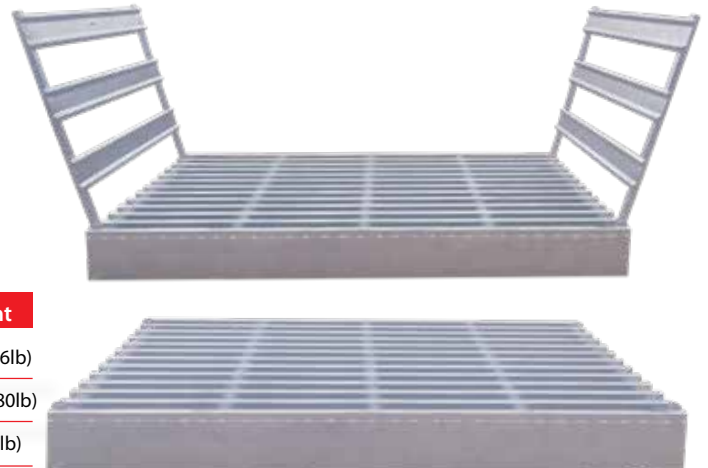

	Width	Depth	Height	Weight
Grid 3.0 <b>CG3</b>	3000 (9.84')	2000 (6.56')	300 (0.98')	420kg(926lb)
Grid 4.0 <b>CG4</b>	4000 (13.12')	2000 (6.56')	300 (0.98')	490kg(1080lb)
Grid Wings <b>CGW</b>	4000 (13.12')	2000 (6.56')	300 (0.98')	36kg(80lb)

# SHEEP LOADING RAMP



## Sheep Loading Ramp

- Manufactured from Galvanised Steel
- Handy lugs for ground pinning
- Fully sheeted
- Fully Adjustable Height for trailer to truck loading.



STANDARD SHEEP RAMP



Optional Walkway Kit Available

		Length	Width	Height	Weight
Standard Ramp	<b>SLR</b>	3055 (10')	650 (2.13')	2250 (7.38')	290kg(640lb)
Walkway Kit	<b>SLRWK</b>				50kg(110lb)

## Light Sheep Floor

- 3 piece design easily flat packed for transport
- Ideal for use with a ute or trailer



		Length	Width	Height	Weight
Light Sheep Floor	<b>SFL</b>	2300 (7.5')	600 (2.0')	900 (3.0')	102kg(225lb)



# CURVED SHEEP RACE



## Curved Race Kit

- Assisting to process a large number of stock at a faster rate, improving productivity.
- Reduces animal stress
- Sheep will move forward looking for an opening

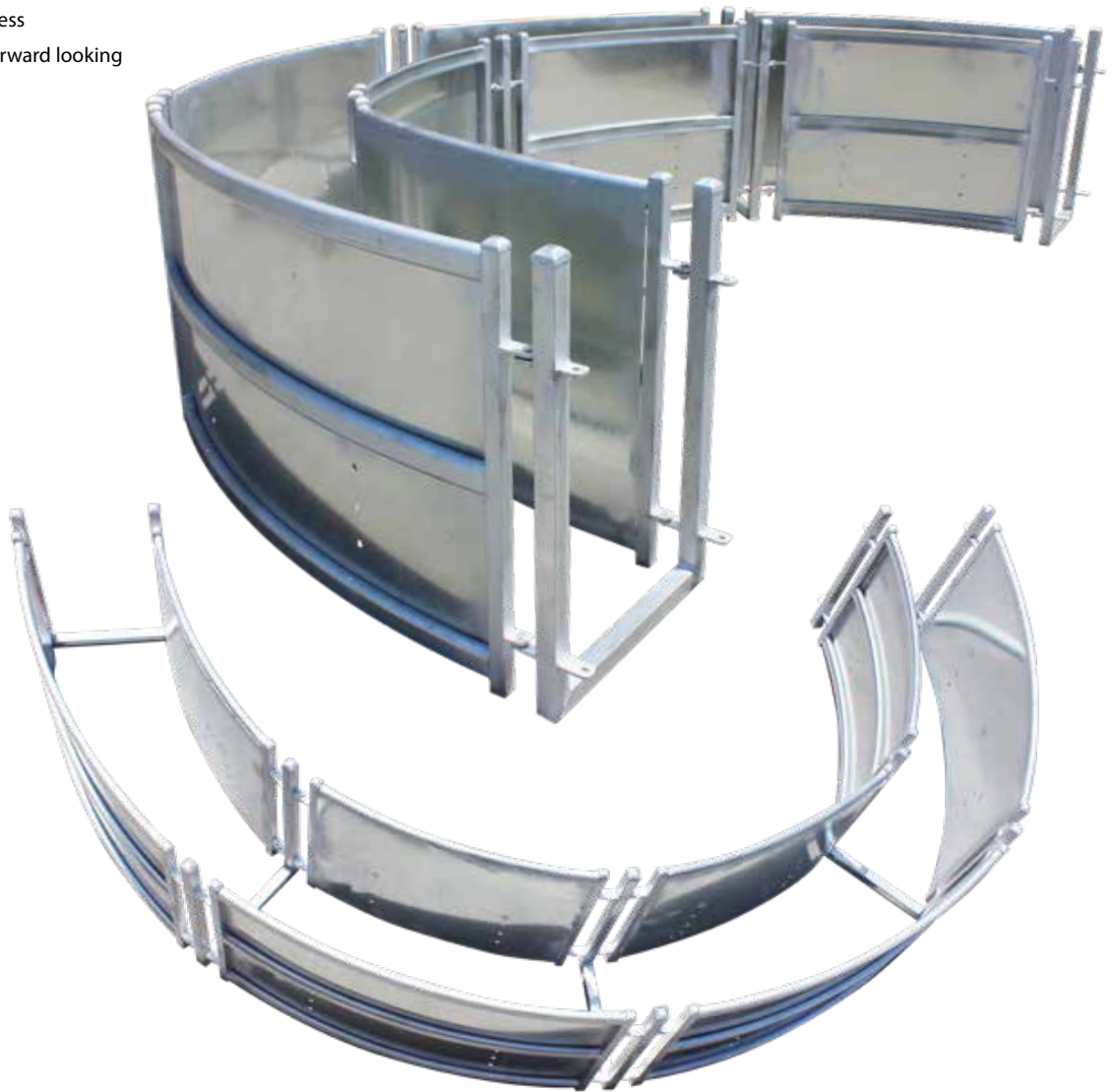

	Width	Depth	Height	Weight
Race Curved Kit <b>SRCK</b>	5010 (16.4')	2500 (8.2')	1000 (3.28')	280kg(617lb)





## Adjustable V-Race

- Manufactured from Galvanised Steel
- Fully sheeted
- The 'v' profile minimises the chance of small stock turning around in the race.
- Races have a fully sheeted outer arc (prevents legs and heads getting out, and improves stock flow)
- Races are made without overhead bracing. This eliminates the danger of an operator getting his arm caught between the yard and beast.



ADJUSTABLE V-RACE

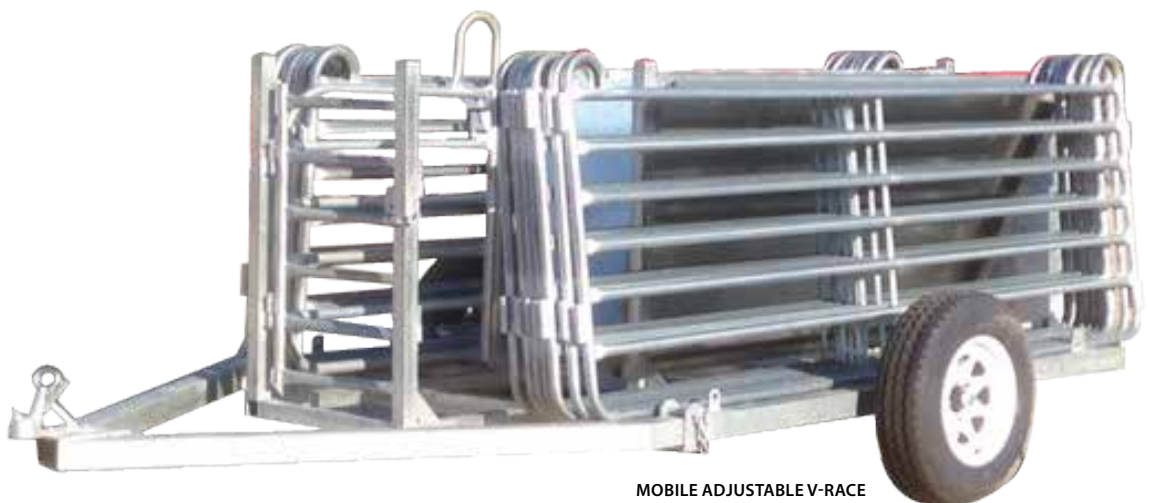

MOBILE ADJUSTABLE V-RACE

		Length	Depth	Height	Weight
Sheep Race	<b>SRA</b>	3410 (11.2')	540 (2.13')	1020 (3.77')	219kg(483lb)
Mobile Race	<b>SRMY</b>	4320 (14.2')	2250 (7.4')	1560(5.12')	350kg(771lb)

**PANELS NOT INCLUDED WHEN ORDERING.**



# PREMIUM SHEEP PANELS & GATES



## Premium Sheep Panels

- Manufactured from Galvanised Steel
- Blind panels are designed to reduce distractions and improve the flow of stock
- Wide top rail for operator comfort when leaning over or accessing yard to yard
- Lamb proof rail spacing
- Height is 1000 mm
- Panels can be used in permanent or portable applications



PREMIUM SHEEP PANEL



GUILLOTINE LIFT-UP SHEEP GATE



PREMIUM BLIND SHEEP PANEL



PREMIUM SHEEP GATE

## Sheep Gates

- Manufactured from Galvanised Steel
- Premium gate are manufactured with 60x30 oval rails and 40x40 posts
- Sliding gates come supplied as conventional push in types, or as push out type



SLIDING SHEEP GATE

		Rail	Uprights	Height	Width
Premium 1.0	SPP1.0	60x30	40x40	1000 (3.28')	1000 (3.28')
Premium 2.0	SPP2.0	60x30	40x40	1000 (3.28')	2000 (6.56')
Premium 3.0	SPP3.0	60x30	40x40	1000 (3.28')	3000 (9.84')
Blind 1.0	SPPB1.0	60x30	40x40	1000 (3.28')	1000 (3.28')
Blind 2.0	SPPB2.0	60x30	40x40	1000 (3.28')	2000 (6.56')
Blind 3.0	SPPB3.0	60x30	40x40	1000 (3.28')	3000 (9.84')
Premium Race	SGPR	60x30	40x40	1000 (3.28')	550 (1.80')
Premium Draft	SGP1.0	60x30	40x40	1000 (3.28')	1000 (3.28')
Premium Gate 2.1	SGP2.1	60x30	40x40	1000 (3.28')	2100 (6.56')
Premium Gate 3.0	SGP3.0	60x30	40x40	1000 (3.28')	3000 (9.84')
Guillotine Gate	SGPG	40x40	20x20	2160 (7.09')	650 (2.13')
Sliding Gate	SGPS	50x25	30x30	1135 (3.72')	765 (2.51')

# BRAZZEN SHEEP PANELS & GATES



## Brazen 7 Rail

- 7 rail - 32od pipe
- Manufactured from Galvanised Steel
- Light weight
- Ideal for portable yards

		Rail	Uprights	Height	Width
Brazen 3.0	<b>SPB-7</b>	32OD	32OD	1000 (3.28')	3000 (9.84')
Brazen Blind 1.0	<b>SPBB1.0</b>	32OD	32OD	1000 (3.28')	1000 (3.28')
Brazen Blind 2.0	<b>SPBB2.0</b>	32OD	32OD	1000 (3.28')	2000 (6.56')
Brazen Blind 3.0	<b>SPBB3.0</b>	32OD	32OD	1000 (3.28')	3000 (9.84')



BRAZZEN SHEEP PANEL

## Brazen Gates



1M DRAFT GATE



RACE GATE

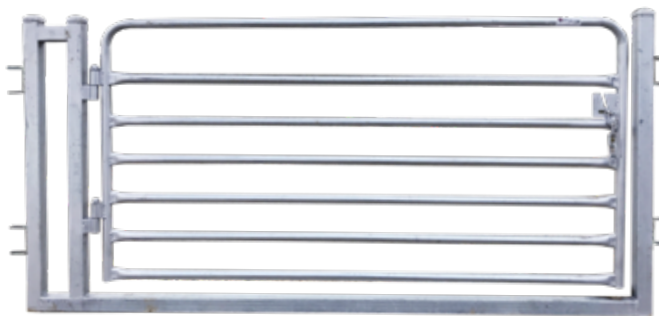

BRAZZEN SHEEP GATE



PERMANENT POST



RACE BOW

		Rail	Uprights	Height	Width
Brazen 2.1	<b>SGB2.1</b>	32OD	32OD	1000 (3.28')	3000 (9.84')
Brazen 3.0	<b>SGB3.0</b>	32OD	40x40	1000 (3.28')	2000 (6.56')
Brazen Draft	<b>SGB1.0</b>	32OD	40x40	1000 (3.28')	1000 (3.28')
Race Gate	<b>SGR</b>	32OD	40x40	1000 (3.28')	550 (1.80')
Race Bow	<b>SRBB</b>		40x40	1000 (3.28')	550 (1.80')
Perm. Post	<b>SPP</b>		50x50	1785 (5.85')	
T-Post	<b>STP</b>		50x50		





# HORSE FLOAT PANELS/SHELTER



## Horse FLOAT Panels

- Powder coated
- Ideal for temporary holding yards
- Portable light weight panels
- 2x panel pieces make a 2m x 2m holding pen

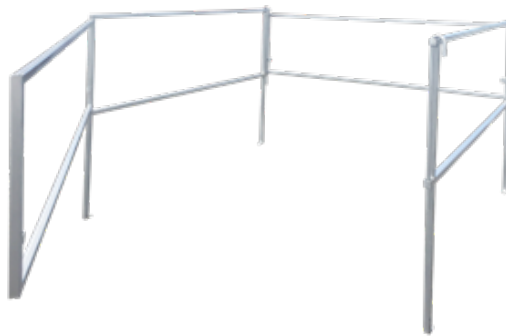

	Height	Width Folded	Width Flat	Weight
Horse Float Panel <b>HFP2.0</b>	1250mm (4.1')	2000mm (6.6')	4000mm (13.2')	14kg(30lb)

## Horse Shelter

- Suitable shelter for animals, stock feed and machinery
- Providing shelter along with air flow for all conditions
- Lined with heavy duty marine ply to protect stock from injury
- Supplied in flat pack
- Anchor plates so you can bolt the shelter down
- Handy lugs on the front so you can attach a gate/s.



	Width	Depth	Height	Weight
Horse Shelter <b>HPS</b>	3000mm (9.84')	3000mm (9.84')	2280mm (7.48')	590kg(1278lb)

# HORSE PANELS & GATES



## Horse Panels

### Round Yard Diameter Specifications (Approx.)

10m	13 panels plus 1 gate = 14 Units
12m	15 panels plus 1 gate = 16 Units
13m	17 panels plus 1 gate = 18 Units
14m	19 panels plus 1 gate = 20 Units
15.5m	21 panels plus 1 gate = 22 Units
16.7m	23 panels plus 1 gate = 24 Units
18m	25 panels plus 1 gate = 26 Units
20m	27 panels plus 1 gate = 28 Units



		Horizontal	Uprights	Rails	Height	Width	Weight
Horse Panel	<b>HP2.1</b>	60x30	40x40	5	1650 (5.41')	2100 (6.89')	23.5kg(52lb)

## High Top Horse Gate

- Height adjustable to 3.0m allowing the option to ride through gates
- Gate is hinged to swing in both directions



		Horizontal	Uprights	Rails	Height	Width	Weight
Horse Gate	<b>HGA</b>	60x30	40x40	5	3000 (9.84')	2100 (6.89')	64kg(141lb)



# CATTLE FEEDERS



## Round Hay Feeder

- Holds 6 ft round bales
- Feeds up to 14 animals simultaneously
- 3 Piece construction makes it easy to relocate
- Manufactured from hot dipped galvanised pipe



	Width	Depth	Height	Weight
FR	2000 (6.56')		1050 (3.44')	100kg(220lb)

## Rectangle Hay Feeder

- Holds 2x6 ft round bales
- Feeds up to 20 animals simultaneously
- 4 Piece construction makes it easy to relocate
- Manufactured from hot dipped galvanised pipe



	Width	Depth	Height	Weight
FS	3477 (11'4")	1791 (5'9")	1050 (3'4")	124kg(273lb)

## Cattle Large Square Bale

- Holds large rectangle bales
- Keeps bales raised off the ground
- Manufactured from hot dipped galvanised pipe



	Width	Depth	Height	Weight
FSC	2900(9.5')	1500(4.92')	1080(3.54')	128kg(282lb)





## Cradle Sheep Feeder

- Full 32NB Pipe
- Holds 1 x round bales

	Width	Depth	Height	Weight
<b>FRC</b>	1645(5'5")	1532 (5'0")	1216(4'0")	80kg(176lb)



## Large Cradle Sheep Feeder

- Full 32NB Pipe
- Holds 2 x round bales or 1 large square bale

	Width	Depth	Height	Weight
<b>FSCS</b>	2900(9'5")	2250(7'4")	1216(4'0")	138kg(304lb)

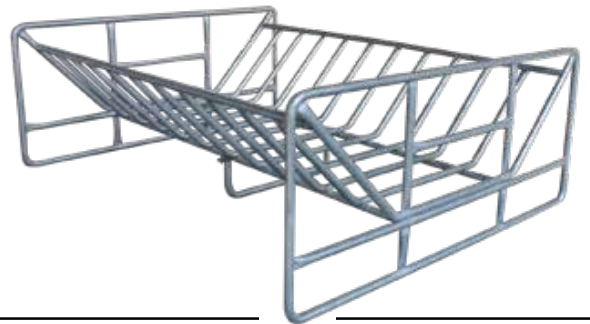

## Hay & Grain Feeder

- Holds large square bales
- Idea for catching and feeding grain
- Manufactured from hot dipped galvanised pipe

	Width	Depth	Height	Weight
<b>FHG</b>	3200(10'5")	1504(4'9")	1800(5'9")	188kg(415lb)



## Sheep Hay Trolley

- Ideal to keep the weather off stock-feed
- Reduces waste
- Supplied with 4 x 254mm (10") wheels x 25mm (1") bore with rubber tyre with 799mm (2'7½") wide lid c/w protex fastening and lid catch
- Double sided 76mm x 76mm hay-rack

	Width	Depth	Height	Weight
<b>FTS</b>	1250 (4.1')	600(1'9")	700(2'3")	52kg(115lb)





# LICK FEEDERS



## Lick Feeders

- Unique barrel design increases strength and does away with the need for internal supports
- Sizes available 800ltr, 2400ltr, 3200ltr, 4200ltr & 5200ltr
- Fully Adjustable
- Full top hinge opening lid
- 3 viewing feed level indicators
- Robust galvanised construction with fork slots for easy moving



		Length	Width	Height	Weight
800ltr	<b>SFL800</b>	1171(3.8')	1232(4.0')	1435(4.7')	151(322lb)
2400ltr	<b>SFL24</b>	2265 (7.4')	1147 (3.76')	1750 (5.74')	315kg(695lb)
3200ltr	<b>CFL32</b>	2265 (7.4')	1167 (3.83')	2100 (6.89')	394kg(867lb)
4200ltr	<b>CFL42</b>	2265 (7.4')	1405 (4.61')	2250 (7.38')	446kg(893lb)
5200ltr	<b>CFL52</b>	2919(9.5')	1574(5.16')	2223(7.29')	520kg(1146lb)
2800ltr Budget	<b>SFLB28</b>	2270(7.45')	1479(4.85')	1643(5.39')	316kg(696lb)

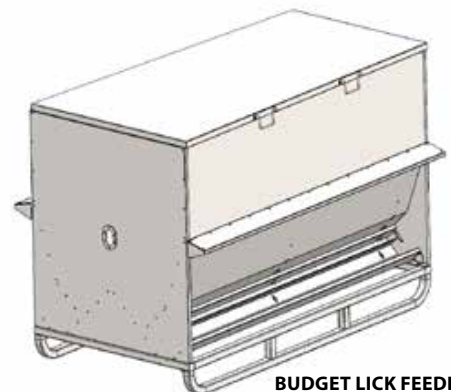

BUDGET LICK FEEDER



## Bale Trailer

- Manufactured from Galvanised Steel
- Holds 6ft round bales
- Easy flow system
- Comes with additional wire feed pin



Comes with additional  
**Wire Feed Pin**

Bale Trailer

TB







# ATV TRAILER



## ATV Trailer

- 5 x 3 ft
- Tipping Feature
- Removable Cage

### Materials

- Standard 2mm flat plate
- 10inch sides
- 50x50x2mm draw bar
- 50mm coupling
- 45mm hollow axle
- 13inch sunraysia ford tyres
- 30x30 RHS chassis
- Cage 25nb pipe frame with 50x50x4mm mesh 900mm high.



ATV Trailer

TATV





## Dog Pens

- Available in single, double and single raised
- Sturdy Construction and design
- Providing great protection for your pets

### Materials

Frame 30x30x1.6mm galvanised tube  
 Mesh: 25x84mm with 3mm diameter hot dip gal



STANDARD SINGLE



RAISED SINGLE



STANDARD DOUBLE

	Depth	Width	Height	Weight
DCS	3660 (12')	2150 (7.05')	1830 (6')	206kg(454lb)
DCR	3660 (12')	2400 (7.87')	1830 (6')	443kg(977lb)
DCD	3660 (12')	2400 (7.87')	1830 (6')	278kg(613lb)



# TASRURAL

---

S U P P L I E S

## Contact & Sales

---

9 Kyeema Place,  
Cambridge 7170

Office: (03) 6245 1663  
Phone: 0414 832 494

[www.tasrural.supplies](http://www.tasrural.supplies)  
[admin@tasrural.supplies](mailto:admin@tasrural.supplies)



DESIGNED & TESTED BY  
FARMERS WORLDWIDE





# TASRURAL

S U P P L I E S

## PRICE LIST



# BRAZZEN

RURAL PRODUCTS

*TasRural*



2019

**CATTLE**
**CRUSHES**

CCSFP	STANDARD Flat Pack Cattle Crush	3,300.00	330.00	3,630.00
CCSFPO	STANDARD Flat Pack Cattle Crush - OFFSIDE	3,700.00	370.00	4,070.00
CCPFP	PREMIUM Flat Pack Cattle Crush - with Baulk	4,000.00	400.00	4,400.00
CCPFPH	PREMIUM Flat Pack Cattle Crush - HDG with Baulk	4,400.00	440.00	4,840.00
CCPSFP	PREMIUM SQUEEZE Flat Pack Cattle Crush	7,100.00	710.00	7,810.00
CHB	Cattle Head Bale	850.00	85.00	935.00
CHBH	Cattle Head Bale HDG	1,050.00	105.00	1,155.00
CLS	Load Scales	1,100.00	110.00	1,210.00
CCF	Crush Floor	380.00	38.00	418.00
CCCL	CHIN lift with Extension Bow	970.00	97.00	1067.00

**RAMPS**

CRFP	STANDARD Flat Pack Loading Ramp	1,800.00	180.00	1,980.00
CRFPH	STANDARD Flat Pack Loading Ramp HDG	2,200.00	220.00	2,420.00
CRPFP	PREMIUM Flat Pack Loading Ramp	2,100.00	210.00	2,310.00
CRPFPH	PREMIUM Flat Pack Loading Ramp HDG	2,500.00	250.00	2,750.00
CRWK	Cattle Loading Ramp Walkway Kit	350.00	35.00	385.00
CRSM	STANDARD Mobile Loading Ramp Flat Pack	2,800.00	280.00	3,080.00
CRPM	PREMIUM Mobile Loading Ramp Flat Pack	4,200.00	420.00	4,620.00

**PANELS**

CPB2.1	Budget Cattle Panels 2.1	90.00	9.00	99.00
CPS1.25	Standard Cattle Panels 1.25	90.00	9.00	99.00
CPS2.1	Standard Cattle Panels 2.1	104.55	10.45	115.00
CPS2.4	Standard Cattle Panels 2.4	140.00	14.00	154.00
CPS3.35	Standard Cattle Panels 3.35	\$165.45	\$16.55	\$182.00
CPP2.1	Premium Cattle Panels (115mm) 2.1 (6 Rail)	140.00	14.00	154.00
CPP2.1H	Premium Cattle Panels HDG (115mm) 2.1 (6 Rail)	195.45	19.55	215.00
CPP2.4H	Premium Cattle Panels HDG (115mm) 2.4 (6 Rail)	227.27	22.73	250.00
CPP3.35H	Premium Cattle Panels HDG (115mm) 3.35 (6 Rail)	318.18	31.82	350.00
CPP3.78H	Premium Cattle Panels HDG (115mm) 3.78 (6 Rail)	354.55	35.45	390.00
CPCI	Curved Race Panels - Inner	500.00	50.00	550.00
CPCO	Curved Race Panels - Outer	540.00	54.00	594.00

**GATES**

CGA	Standard Access Gate 1.25 - Slam Latch/Chain	290.00	29.00	319.00
CGS2.1	Standard Gate 2.1 - Slam Latch/Chain	300.00	30.00	330.00
CGS3.0	Standard Gate 3.0 - Slam Latch/Chain	600.00	60.00	660.00
CGSS	Standard Sliding Gates	480.00	48.00	528.00
CGSMP	Standard Man Panel Gate 2.1	300.00	30.00	330.00
CGSMP2.4	Standard Man Panel Gate 2.4	370.00	37.00	407.00
CGR2W	Standard 2 Way Race Gate	600.00	60.00	660.00
CGST	Standard Spear Trap Gate	700.00	70.00	770.00

\$

GST TOTAL \$

## CATTLE

GATES

CGPASHH	Premium Access Gate 1.25 HDG - Slam Latch/Chain	420.00	42.00	462.00
CGPH	Premium Gate 2.1 HDG - Slam Latch/Chain	460.00	46.00	506.00
CGS4.2H	Premium Gate 4.2 HDG - Slam Latch/Chain	1,100.00	110.00	1,210.00
CGP2WS	Premium Sliding Gate - Two Way HDG	600.00	60.00	660.00
CGPMPH	Premium Man Panel Gate HDG	430.00	43.00	473.00
CGPMP2.4H	Premium Man Panel Gate 2.4 HDG	500.00	50.00	550.00

RACE BOWS

CRB	Cattle Race Bow	90.00	9.00	99.00
CRBH	Cattle Race Bow HDG Bending Bow	125.45	12.55	138.00
CRBD	Double Race Walkway Bow	186.36	18.64	205.00
CRBDH	Double Race Walkway Bow HDG	200.00	20.00	220.00

DRAFT

C3WD	Cattle 3 Way Draft	1,600.00	160.00	1,760.00
C3WDH	Cattle 3 Way Draft HDG	1,900.00	190.00	2,090.00
CCCT	Cattle Calf Cradle/Table Standard	1,800.00	180.00	1,980.00

POSTS

CP	Cattle Posts - 2500mm	60.00	6.00	66.00
CPH	Cattle Posts HDG - 2500mm	90.00	9.00	99.00

RACE MESH

CRWW	Race Walkway Mesh	180.00	18.00	198.00
CRWWH	Race Walkway Mesh HDG	220.00	22.00	242.00
CASR	Race Anti-Slip Insert	170.00	17.00	187.00

FORCE YARD

CFYB	Force Yard - Blind	3,000.00	300.00	3,300.00
CFYBH	Force Yard - Blind HDG	4,000.00	400.00	4,400.00
CFYBO	Force Yard - Blind OFFSIDE	3,500.00	350.00	3,850.00

## CATTLE GRID

GRIDS

CG4	4m Cattle Grid	1650.00	165.00	1815.00
CGW	Wings (Pair)	300.00	30.00	330.00

## SHEEP

RACE

SRA	Adjustable Sheep Race	1,600.00	160.00	1,760.00
SRMY	Mobile Sheep Race	2,800.00	280.00	3,080.00
SPI	Curved Race Panels - Inner	220.00	22.00	242.00
SPO	Curved Race Panels - Outer	230.00	23.00	253.00

RAMPS

SFL	Sheep Light Floor	1,000.00	100.00	1,100.00
SLR	Sheep Loading Ramp - Flat Pack	1,500.00	150.00	1,650.00
SLRM	Sheep Loading Ramp Mobile	3,000.00	300.00	3,300.00
SRWK	Sheep Loading Ramp Walkway Kit	350.00	35.00	385.00

PANELS

SPB-7	Brazen 7 Rail Sheep Panels 3.0	90.00	9.00	99.00
SPP1.0	Premium Sheep Panel 1.0	80.00	8.00	88.00
SPP2.0	Premium Sheep Panel 2.0	90.00	9.00	99.00
SPP2.5	Premium Sheep Panel 2.5	100.00	10.00	110.00
SPP3.0	Premium Sheep Panel 3.0	115.00	11.50	126.50



## SHEEP

PANELS

SPB1.0	Premium Blind Sheep Panel 1.0	130.00	13.00	143.00
SPB2.0	Premium Blind Sheep Panel 2.0	150.00	15.00	165.00
SPB3.0	Premium Blind Sheep Panel 3.0	170.00	17.00	187.00

GATES

SGR	Brazzen Sheep Race Gate in Frame - 550mm	120.00	12.00	132.00
SGD	Brazzen Sheep Drafting Gate - 1.0	150.00	15.00	165.00
SGB-7	Brazzen 7 Rail Sheep Gate - 2.1	230.00	23.00	253.00
SGB-8	Brazzen 7 Rail Sheep Gate - 3.0	270.00	27.00	297.00
SGPG	Premium Guillotine/Lift Up Sheep Gate	200.00	20.00	220.00
SGLU	Premium Sheep Sliding Gate	210.00	21.00	231.00
SGP2.0	Premium Sheep Gate - 2.0	270.00	27.00	297.00
SGP2.5	Premium Sheep Gate - 2.5	280.00	28.00	308.00
SGP3.0	Premium Sheep Gate - 3.0	300.00	30.00	330.00

POSTS - BOW

SRB	Sheep Race Bow	90.00	9.00	99.00
SP	Sheep Posts - 1785mm	50.00	5.00	55.00
STP	Sheep T Posts	40.00	4.00	44.00

## HORSE

PANELS

CPB2.1	Horse Panel - 6 Rail - 2.1 (60x30)	90.00	9.00	99.00
HPF2.1P	Horse Float Panel 2.0-4.0 Powder Coated	130.00	13.00	143.00

GATES

HG3.0	Standard Gate - 3.0M High	\$350.00	\$35.00	\$385.00
-------	---------------------------	----------	---------	----------

SHELTER

HPS	Horse Shelter	1909.09	190.91	2100.00
-----	---------------	---------	--------	---------

## FEEDERS

FEEDERS

FR	Cattle Round Hay Feeder	390.00	39.00	429.00
FRH	Cattle Round Hay Feeder - Heavy	500.00	50.00	550.00
FS	Cattle Rectangle Hay Feeder	600.00	60.00	660.00
FSC	Cattle Large Square Bale - SPECIAL ORDER	550.00	55.00	605.00
FRC	Sheep Hay Cradle	500.00	50.00	550.00
FSCS	Sheep Large Cradle Feeder - SPECIAL ORDER	600.00	60.00	660.00
FHG	Hay & Grain Feeder	1,200.00	120.00	1,320.00
FTS	Sheep Hay Trolley	450.00	45.00	495.00
TBL	Bale Loader	1,100.00	110.00	1,210.00
FL24FP	Lick Feeder 2400ltr - Flat Pack	1,950.00	195.00	2,145.00
FL32FP	Lick Feeder 3200ltr - Flat Pack	2,350.00	235.00	2,585.00
FL42FP	Lick Feeder 4200ltr - Flat Pack	2,850.00	285.00	3,135.00

## TRAILERS

TRAILER

TATV	ATV Trailer	1,300.00	130.00	1,430.00
------	-------------	----------	--------	----------

## DOG PENS

DOG PENS

DPS	Dog Pen - Single	900.00	90.00	990.00
DPS	Dog Pen - Single RAISED	1,400.00	140.00	1,540.00
DPD	Dog Pen - Double	1,200.00	120.00	1,320.00